



# Warehouse safety manual

Operation, use, inspection, and maintenance of mezzanines



---

## CONTENTS

### MANUAL FOR THE USE AND MAINTENANCE OF MEZZANINES

<b>3</b>	<b>Introduction</b>
<b>4</b>	<b>Mezzanine floor elements</b>
4	Floor slab
4	Mezzanine structure
5	Sigma mezzanines
5	GL mezzanines
5	Mixed mezzanine system
7	Mezzanine flooring
8	Handrails and gates
9	Staircases and landings
<b>9</b>	<b>Considerations to take into account</b>



## INTRODUCTION

All warehouses in operation hold productivity and work conditions as universally important concepts. Above all, care must be taken to ensure safe conditions for the use of storage equipment and to avoid exposing personnel to any risk.

A well-maintained mezzanine floor facilitates all work carried out on it. However, misuse of any part of this storage system may result in accidents.

To avoid situations involving the potential risk of personal injury, costly interruptions to service or damage to the facility or the goods, the following measures should be taken:

- **Prevention:** personnel must be trained to use the facility and equipment properly.
- **Inspection:** staff should continuously check that all optimal conditions of use are met.
- **Maintenance:** any defective or malfunctioning warehouse element should be immediately attended to or corrected.

An installation is used safely and rationally through collaboration between all users and manufacturers involved.

The Mecalux Group has prepared this manual to provide its customers with guidance on the correct use of the mezzanine floors as regards their structure. It was drafted taking into account the recommendations of European bodies and the EN 15635 European standard "Steel static storage systems. Application and maintenance of storage equipment."

### VERY IMPORTANT:

Responsibility for the surveillance, use and the condition of the installation lies with the customer. The customer must convey the content of this manual to warehouse managers and users.

Users must also comply with the specific standards in force for this type of installation in each country.



---

## MEZZANINE ELEMENTS

The basic components that make up a mezzanine are:

- Floor slab
- Mezzanine structure
- Mezzanine flooring
- Handrails and gates
- Staircases and landings

Each installation can include all or part of these elements. They can be found in the drawings provided and in the technical document provided with the quote.

### FLOOR SLAB

The floor slab is a basic structural element usually made of mass concrete or reinforced concrete. For its construction, the following must be taken into account:

- Its **stability and strength characteristics** must be appropriate to withstand the force exerted by the loads, the mezzanine and the handling equipment.
- The **thickness of the floor slab** should be ideal for attaching anchors to the bases of the mezzanine columns.
- The **levelness or flatness of the floor slab** must meet the specifications of the EN 15620 European standard.

A ceramic, terrazzo or asphalt-based floor is not suitable for absorbing the force exerted by the structure.



## MEZZANINE STRUCTURE

The structure of a mezzanine generally consists of the following components:

- Pillars or columns
- Main beams
- Secondary beams

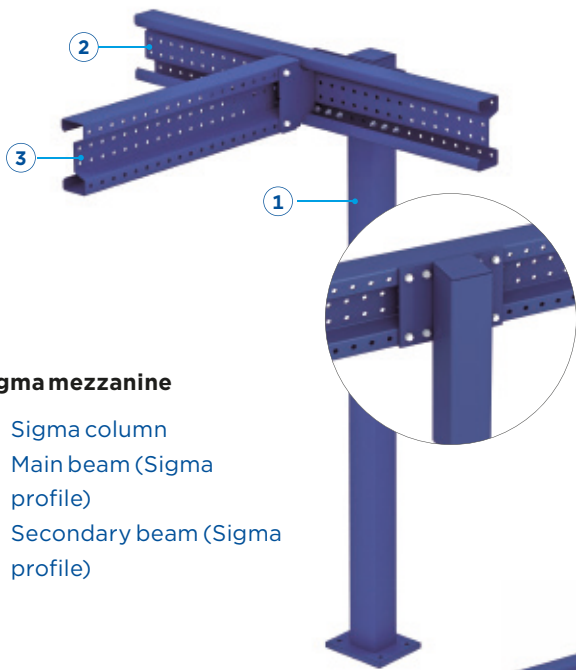

### Sigma mezzanine

1. Sigma column
2. Main beam (Sigma profile)
3. Secondary beam (Sigma profile)



### GL mezzanines

1. GL column
2. Main beam
3. Secondary beam

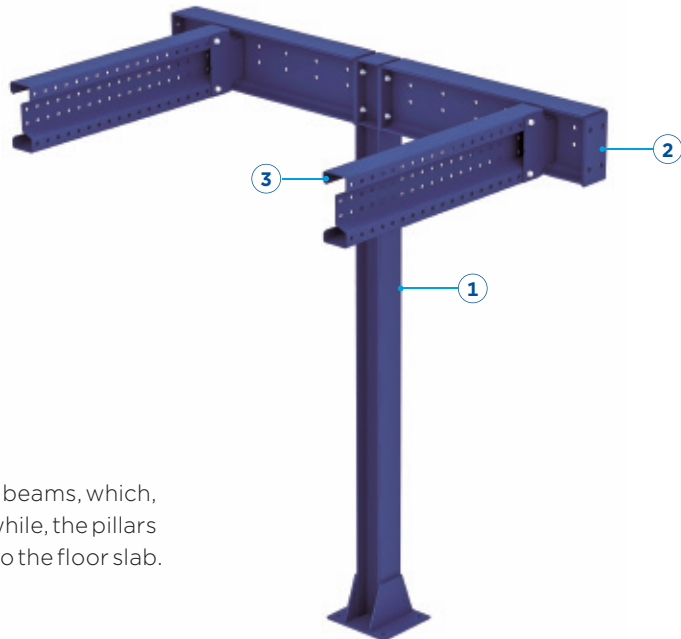

### Mixed mezzanine system

1. HEA GL column
2. Main beam
3. Secondary beam (Sigma profile)

The secondary beams exert the force on the main beams, which, in turn, transmit it to the pillars or columns. Meanwhile, the pillars transmit the forces supported on the mezzanine to the floor slab.

The GL system is the most appropriate for mezzanine structures requiring a certain degree of fire stability.

---

Every project is based on needs and requirements:

- Intended use of the mezzanine.
- Distances or spans between pillars to be observed.
- Loads considered.
- Clearance height.
- Type of floor required.

Taking into account these requirements, Mecalux will propose the ideal construction system:



#### **Sigma mezzanine system**

System for small and medium spans and loads. The structure is made up of cold-formed elements with Sigma profiles.



#### **GL mezzanine system**

This system is appropriate for large-span structures and medium or large loads. The structure is built with standardised hot-rolled profiles (IPN, IPE, etc.).

This system is also recommended when the structure requires a certain degree of fire stability and, thus, is combined with the protection systems available on the market, such as intumescent paint.

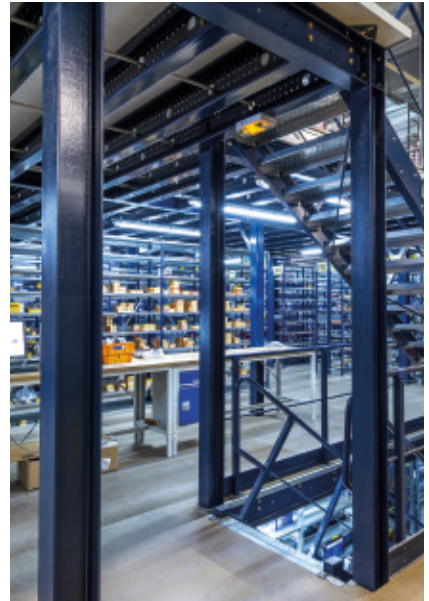

#### **Mixed mezzanine system**

This type is used to build large structures and combines the previous two systems. The structure is composed of main beams based on standardised profiles and secondary beams with Sigma profiles.

## MEZZANINE FLOORING

According to the needs of each project, mezzanine flooring can be made of:

- Structural chipboard
- Chipboard with a sheet metal top finish
- Metal floors



### Chipboard flooring



Chipboard panel flooring

### Metal floors

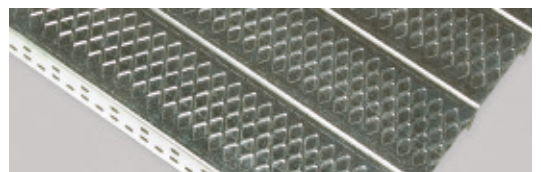

Grooved metal

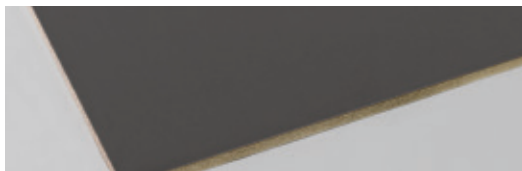

MA/ML melamine chipboard flooring

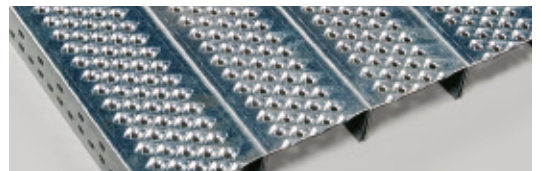

Perforated metal



Wooden flooring with sheet metal

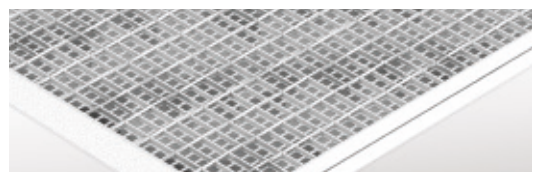

Metal grating

## HANDRAILS AND GATES

It is mandatory to instal handrails around the parts of the mezzanine floor perimeter that do not directly abut the walls.

If it is necessary to enable a goods access area, openings must be made along the handrail. These openings must be safeguarded via systems that prevent them from being left unprotected.



Handrail



Up and over pallet gate



Swing gate

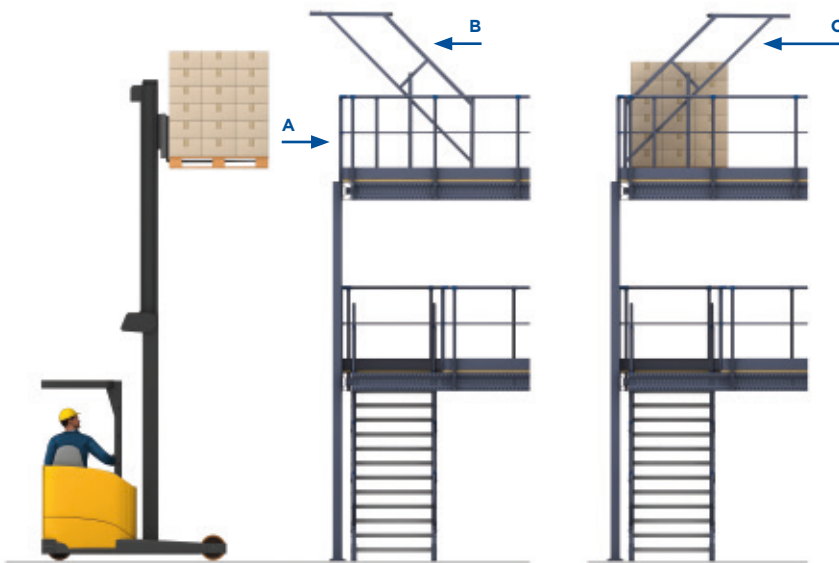

- A. Forklift access
- B. Security gate: access closed to personnel but open to forklifts
- C. Security gate: access closed to forklifts but open to personnel



## STAIRCASES AND LANDINGS

The maximum height to be covered in a single span must not exceed 3 m. If greater heights need to be bridged, stairs with a landing must be installed.

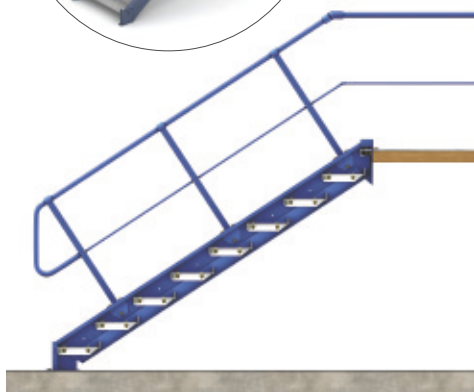

Staircase without a landing



Staircase with a landing (continuous staircase with a landing)

## Considerations to take into account

The following is a list of all aspects that the user of the mezzanine must take into account to minimise risks and avoid accidents. It is vital that the user complies with each and every one of these considerations.

- The user must respect the loads for which the mezzanine has been calculated and that appear in the technical document and on the safe load warning notice. These loads must not be exceeded under any circumstances.
- The safe load warning notice(s) must always be visible.
- The nature of the mezzanine load (uniformly distributed or point loads) may not be modified without prior notice to Mecalux.
- Unless previously indicated, it is forbidden to instal any equipment on the mezzanine that transmits vibrations to it.
- Structural elements, as well as the flooring installed, must not be broken or hit. The use of the installation is prohibited if the structural elements are damaged.
- The user must not change the structure without prior approval from Mecalux.
- The user must not alter (cut, replace, weld, drill, move, etc.) any of the mezzanine's structural elements.
- The initial use of the mezzanine may not be modified without the approval of Mecalux.
- Extreme caution must be exercised in the use of the various pieces of handling equipment that coexist on the mezzanine floor and that could hit it.
- If forklift trucks are operated in the installation and could collide with the pillars, protectors should be placed on the columns.
- The mezzanine perimeter must be protected to prevent any accidental falls. The handrails must be maintained in good condition.
- The gates installed must be safety gates and must be maintained in good condition.

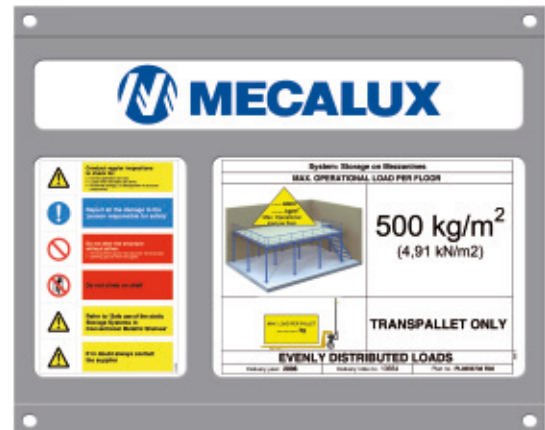

Example of a safe load warning notice



---

In addition to the considerations above, the user must conduct regular inspections and an annual inspection by an expert.



## CUSTOMER'S RESPONSIBILITY

In accordance with European regulations and legislation, the customer is responsible for the safety of persons and for maintaining the handling equipment in safe working order. Hence, the customer is responsible for carrying out the necessary inspections and maintenance, for designating a person in charge of safety, and for preparing a risk prevention plan for the installation.

## HEAD OFFICE - SPAIN

Tel. +34 932 616 913 - info@mecalux.com - mecalux.com

### EUROPE

#### BELGIUM

Tel. +32 2 346 90 71  
info@mecalux.be  
mecalux.be

#### CROATIA

Tel. +386 41 379 122  
pisarna@mecalux.com  
mecalux.hr

#### CZECHIA

Tel. +420 222 524 240  
info@mecalux.cz  
mecalux.cz

#### FRANCE

Tel. +33 01 60 11 92 92  
info@mecalux.fr  
mecalux.fr

#### GERMANY

Tel. +49 (0) 2133 5065 0  
info@mecalux.de  
mecalux.de

#### ITALY

Tel. +39 02 98836601  
info@mecalux.it  
mecalux.it

#### NETHERLANDS

Tel. +31 208 08 30 96  
info@mecalux.nl  
mecalux.nl

#### POLAND

Tel. +48 32-331 69 66  
info@mecalux.pl  
mecalux.pl

#### PORTUGAL

Tel. +351 21 415 18 90  
info@mecalux.pt  
mecalux.pt

#### ROMANIA

Tel. +40 753 098 246  
romania@mecalux.com  
mecalux.ro

#### SLOVAKIA

Tel. + 421 220 545 117  
info@mecalux.sk  
mecalux.sk

#### SLOVENIA

Tel. +386 41 379 122  
pisarna@mecalux.com  
mecalux.si

#### SPAIN

Tel. + 34 932 616 913  
info@mecalux.es  
mecalux.es

#### TURKEY

Tel. +90 216 706 10 15  
info@mecalux.com.tr  
mecalux.com.tr

#### UNITED KINGDOM

Tel. +44 0121 3336 602  
info@mecalux.co.uk  
mecalux.co.uk

### AMERICA

#### ARGENTINA

Tel. +54 (11) 4006-4444  
info@mecalux.com.ar  
mecalux.com.ar

#### BRAZIL

Tel. +55 19 3809-6800  
info@mecalux.com.br  
mecalux.com.br

#### CHILE

Tel. +56 (2) 2827 6000  
info@mecalux.cl  
mecalux.cl

#### COLOMBIA

Tel. +57 018000 423 553  
info@mecalux.com.co  
mecalux.com.co

#### MEXICO

Tel. +52 800 030 0185  
info@mecalux.com.mx  
mecalux.com.mx

#### URUGUAY

Tel. +598 2683-8879  
info@mecalux.com.uy  
mecalux.com.uy

#### USA

Tel. 1-877-632-2589  
info@interlakemecalux.com  
interlakemecalux.com

Mecalux has a presence in more than 70 countries worldwide

Offices in: Argentina - Belgium - Brazil - Canada - Chile - Colombia - Croatia - Czechia - France - Germany  
Italy - Mexico - Netherlands - Poland - Portugal - Romania - Slovakia - Slovenia - Spain - Turkey - United Kingdom  
Uruguay - USA



Mecalux offers its customers a Technical Inspection Service on completion of an installation, as well as yearly inspections, advice and consultancy on damages, modification or expansion of storage systems.

If an accident occurs at your installation, please notify our technical inspection department immediately. We will respond quickly and will properly inspect, identify damages and/or provide repairs to your installation.

We are always in pursuit of the highest quality controls, which has been a cornerstone of how we do business and how we offer better customer care.

